

The laser ion source as a tool for physics at Eurisol

Resonant laser ionisation

Isomeric beams

In-source spectroscopy

Doppler free two photon resonance

Search for the Giant Pairing Vibration at Eurisol

Resonant laser ionisation

V. Fedoseyev et al., HI 127 409 (2000)

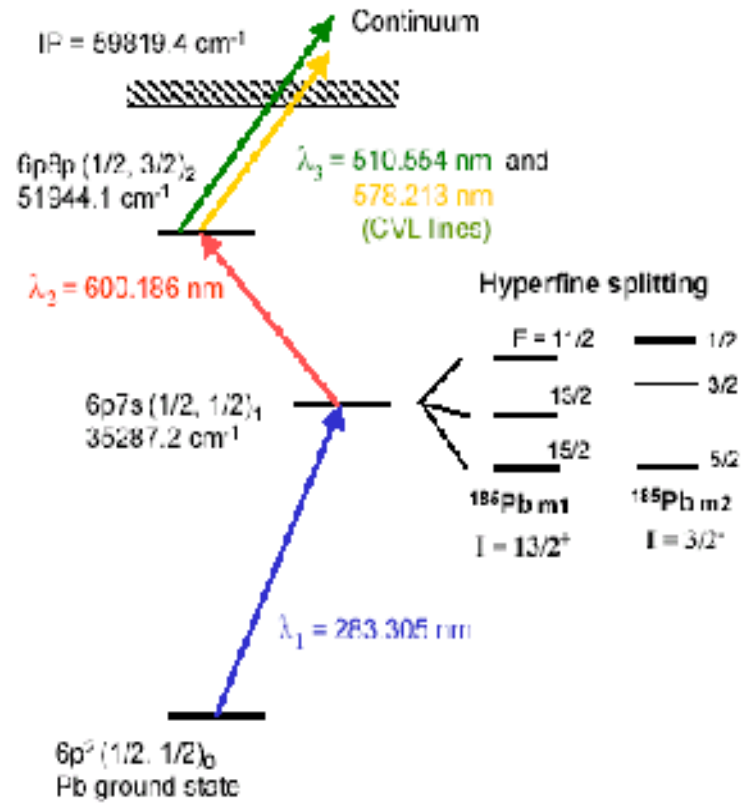
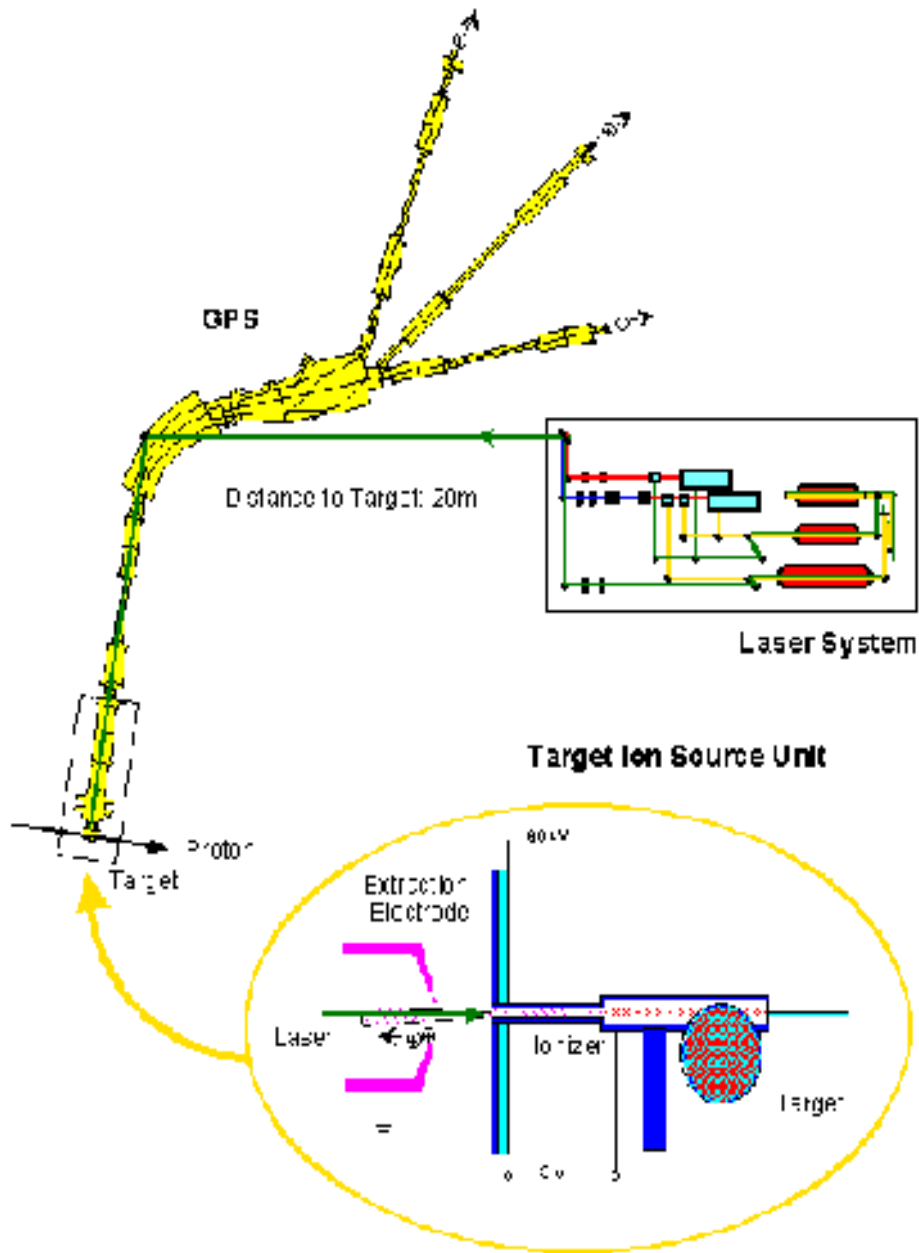

management of radioactive inventory



Resonant laser ionisation

- Elements available at Isolde Rilis
- Elements available at Lisol laser ion guide
- Ionisation scheme tested

1																	2				
H																	He				
3	4															5	6	7	8	9	10
Li	Be															B	C	N	O	F	Ne
11	12															13	14	15	16	17	18
Na	Mg															Al	Si	P	S	Cl	Ar
19	20	21	22	23	24	25	26	27	28	29	30	31	32	33	34	35	36				
K	Ca	Sc	Ti	V	Cr	Mn	Fe	Co	Ni	Cu	Zn	Ga	Ge	As	Se	Br	Kr				
37	38	39	40	41	42	43	44	45	46	47	48	49	50	51	52	53	54				
Rb	Sr	Y	Zr	Nb	Mo	Tc	Ru	Rh	Pd	Ag	Cd	In	Sn	Sb	Te	I	Xe				
55	56	57	72	73	74	75	76	77	78	79	80	81	82	83	84	85	86				
Cs	Ba	La	Hf	Ta	W	Re	Os	Ir	Pt	Au	Hg	Tl	Pb	Bi	Po	At	Rn				
87	88	89	104	105	106	107	108	109	110	111	112										
Fr	Ra	Ac	Rf	Db	Sg	Bh	Hs	Mt	Ds	Rg											

58	59	60	61	62	63	64	65	66	67	68	69	70	71
Ce	Pr	Nd	Pm	Sm	Eu	Gd	Tb	Dy	Ho	Er	Tm	Yb	Lu
90	91	92	93	94	95	96	97	98	99	100	101	102	103
Th	Pa	U	Np	Pu	Am	Cm	Bk	Cf	Es	Fm	Md	No	Lr

large range of extracted beams

U. Köster et al., NIM B 204 347 (2003)
 V. Fedosseev et al., NIM B 204 353 (2003)
 K. Wendt, NIM B204 325 (2003)



In-source spectroscopy

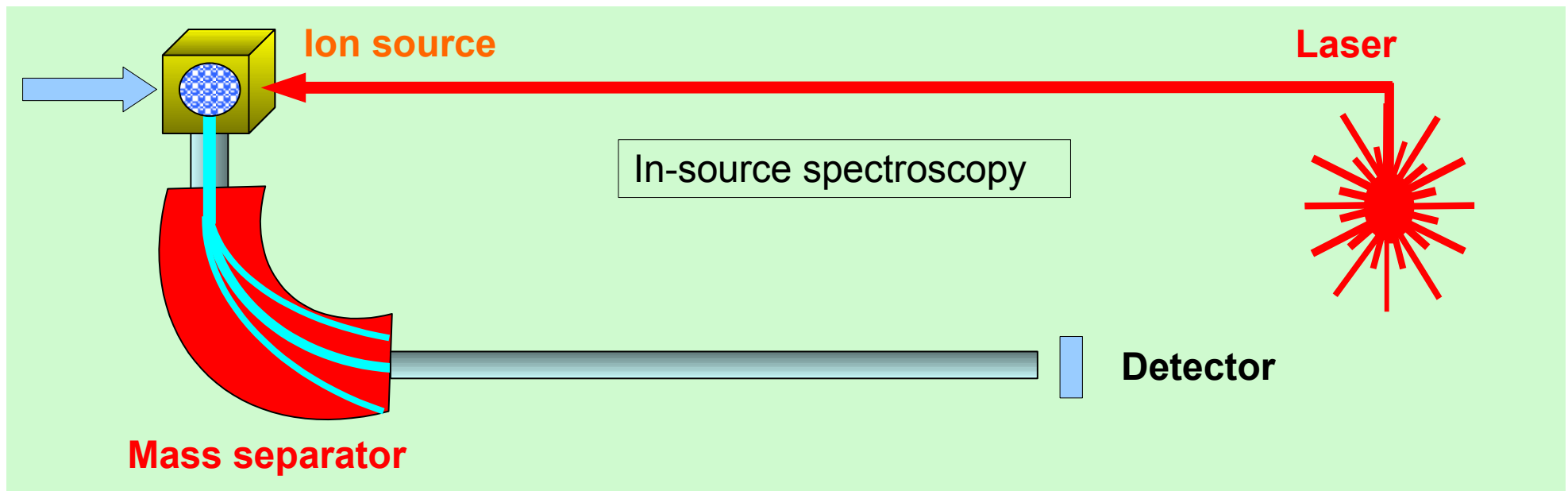
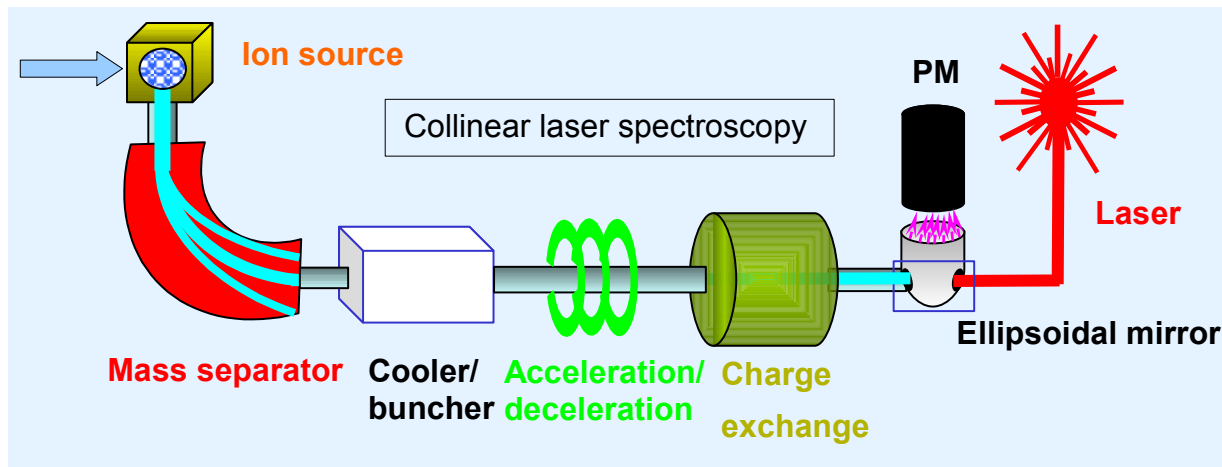

Petersburg NPI:

^{155}Yb , $^{153-154}\text{Tm}$

1-1.7 GHz bandwidth dye laser
(total linewidth 2.5-3 GHz)

G. Alkhazov et al., NIM B69 517 (1992)

A. Barzakh et al., PRC 61 034304 (2000)

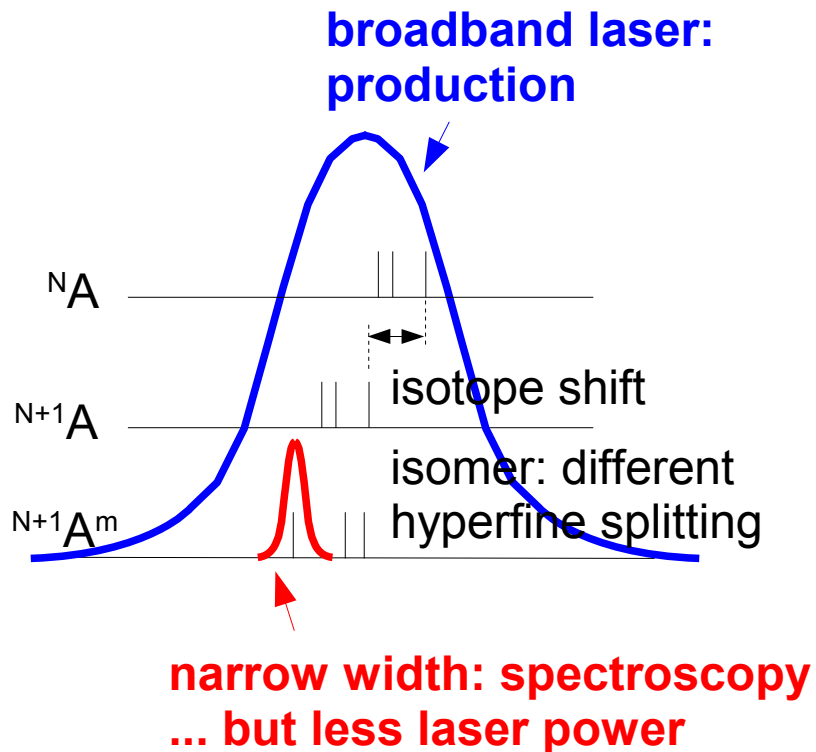
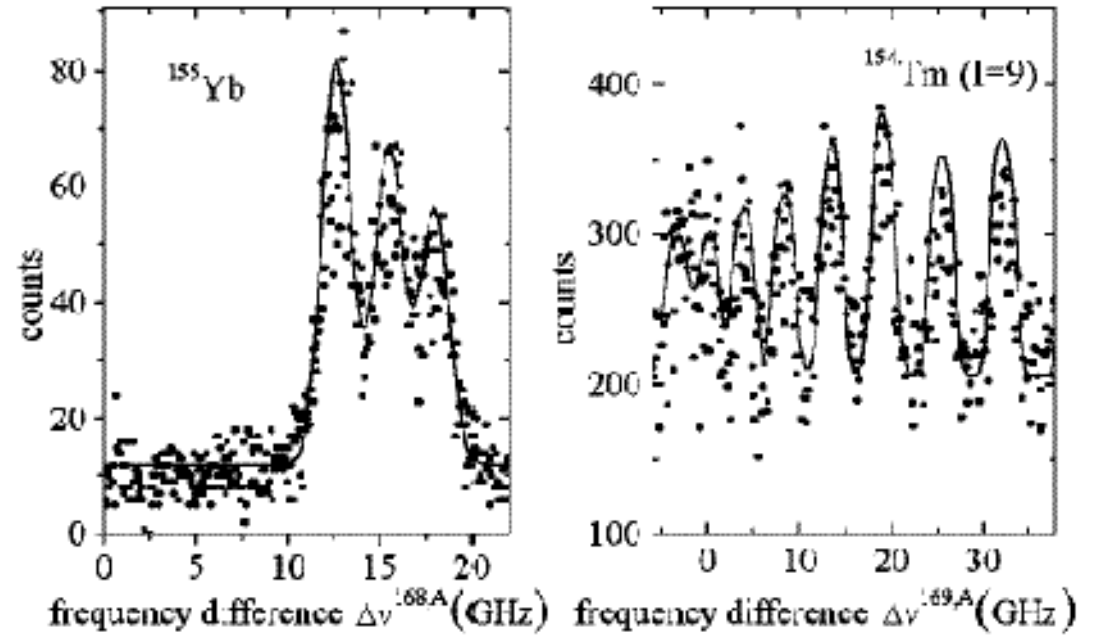

Isolde:

^{7-14}Be , $^{122-129}\text{Ag}$

12 GHz bandwidth dye laser

V. Sebastian et al., Enam-2 126 (1998)

V. Fedoseyev et al., HI 127 409 (2000)

U. Köster et al., HI 127 417 (2000)



$^{68,70}\text{Cu}$

1.2 GHz bandwidth dye laser at 11 kHz repetition rate
 Doppler broadening = 3.8 GHz

L Weissman et al, PRC 65 024315 (2002)

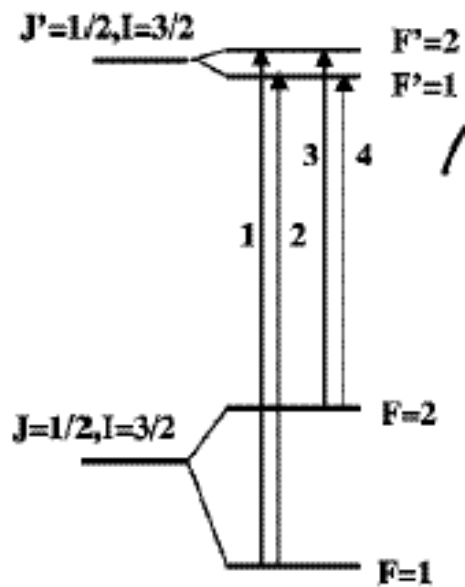

$$E = A \frac{C}{2} + B \frac{\frac{3}{4}C(C+1) - I(I+1)J(J+1)}{2(2I-1)(2J-1)IJ}$$

$$C = F(F+1) - I(I+1) - J(J+1)$$

$$A = \frac{\mu_N B_J}{IJ}$$

$$B = e Q_s V_{JJ}$$

$$\delta v^{AA'} = \underbrace{\left(\frac{A' - A}{AA'} \right) (N + S)}_{\text{normal \& specific mass shift}} + \underbrace{F k \delta \langle r^2 \rangle^{AA'}}_{\text{field shift deformation (Brix \& Kopfermann)}}$$

normal & specific mass shift

field shift deformation
(Brix & Kopfermann)



In-source spectroscopy

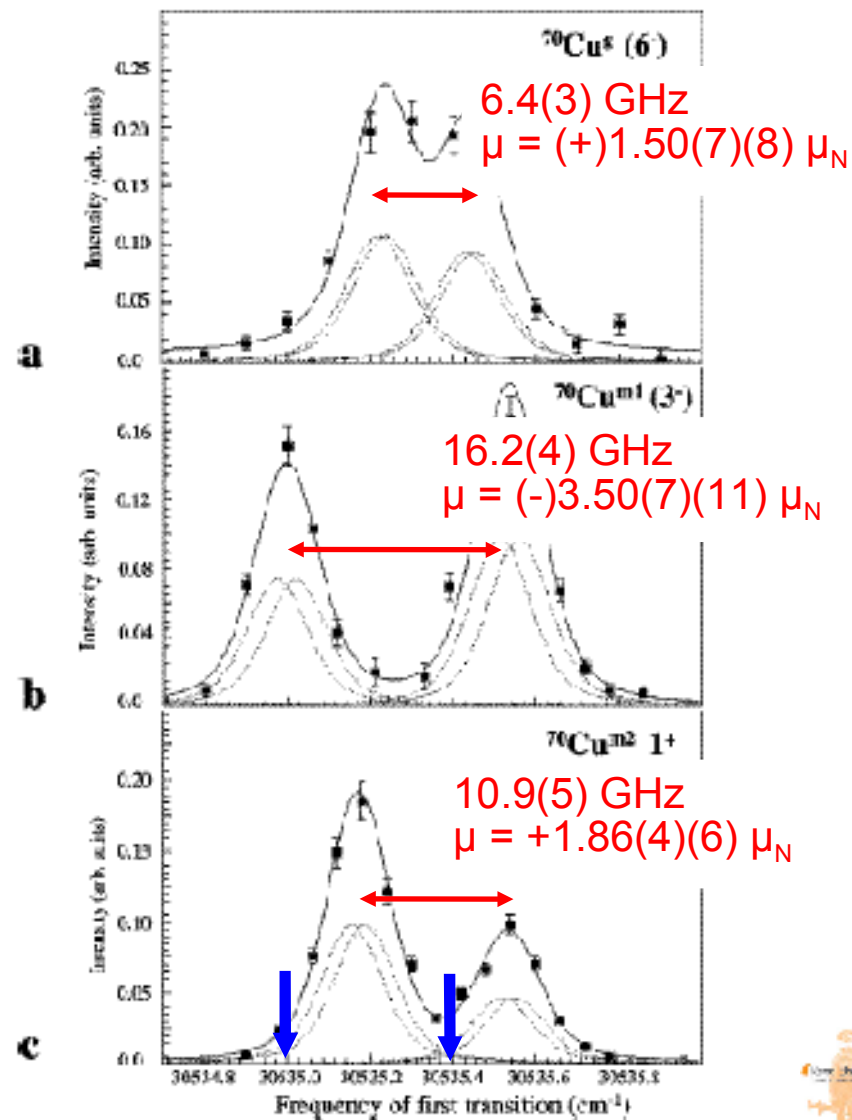
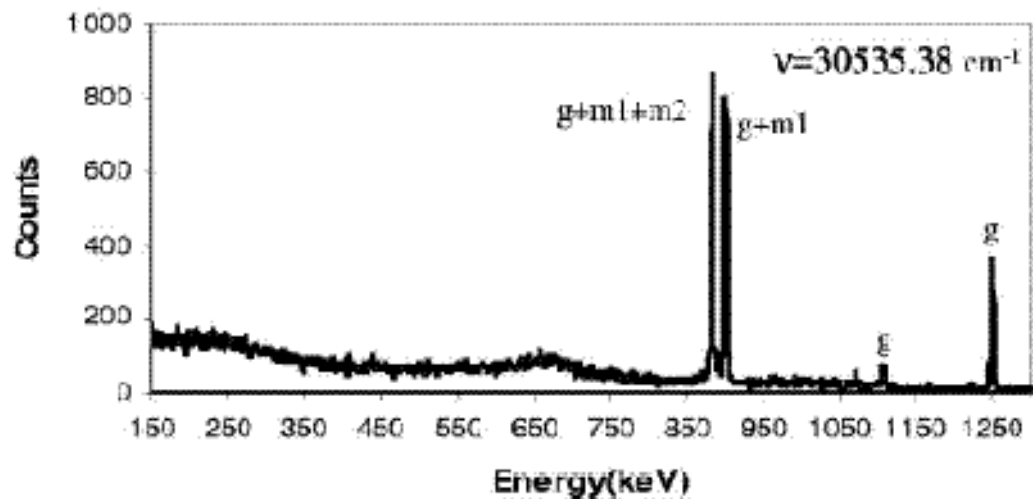
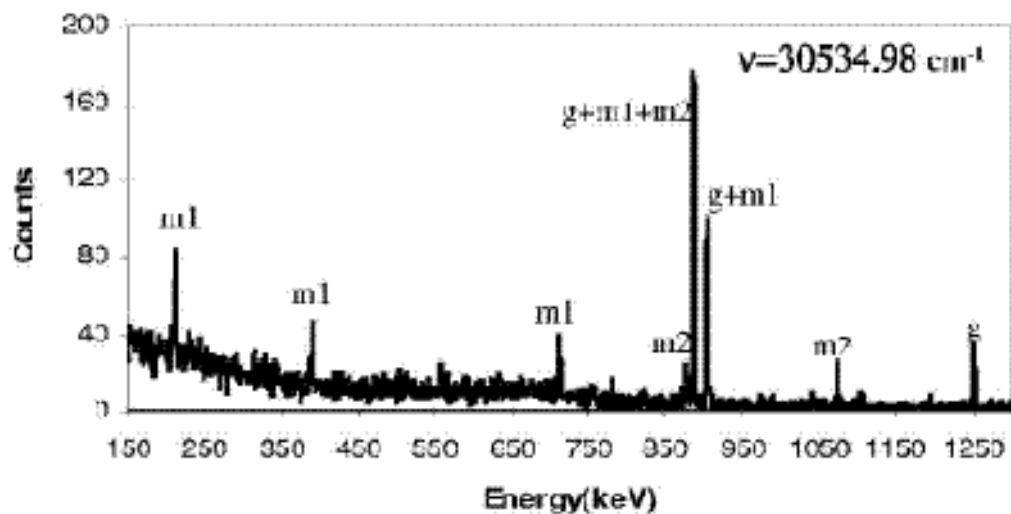
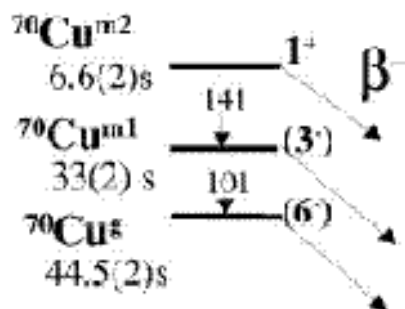

In-source spectroscopy

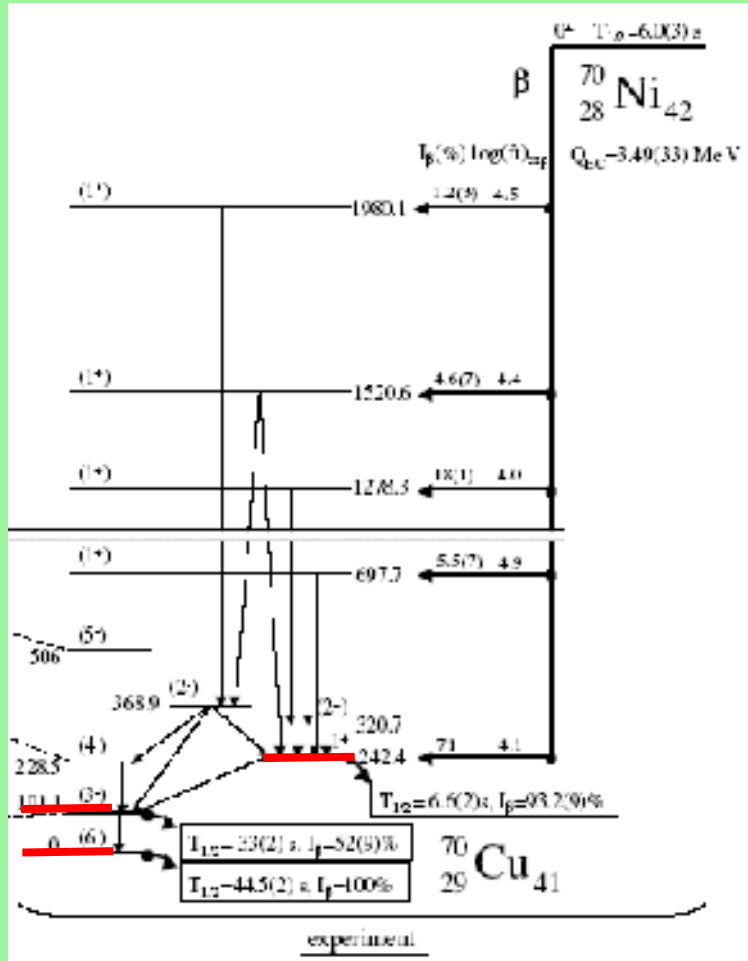

J. Van Roosbroeck et al.,
PRL 92 112501 (2004)



Isoltrap

G. Bollen, K. Blaum, H.-J. Kluge et al.

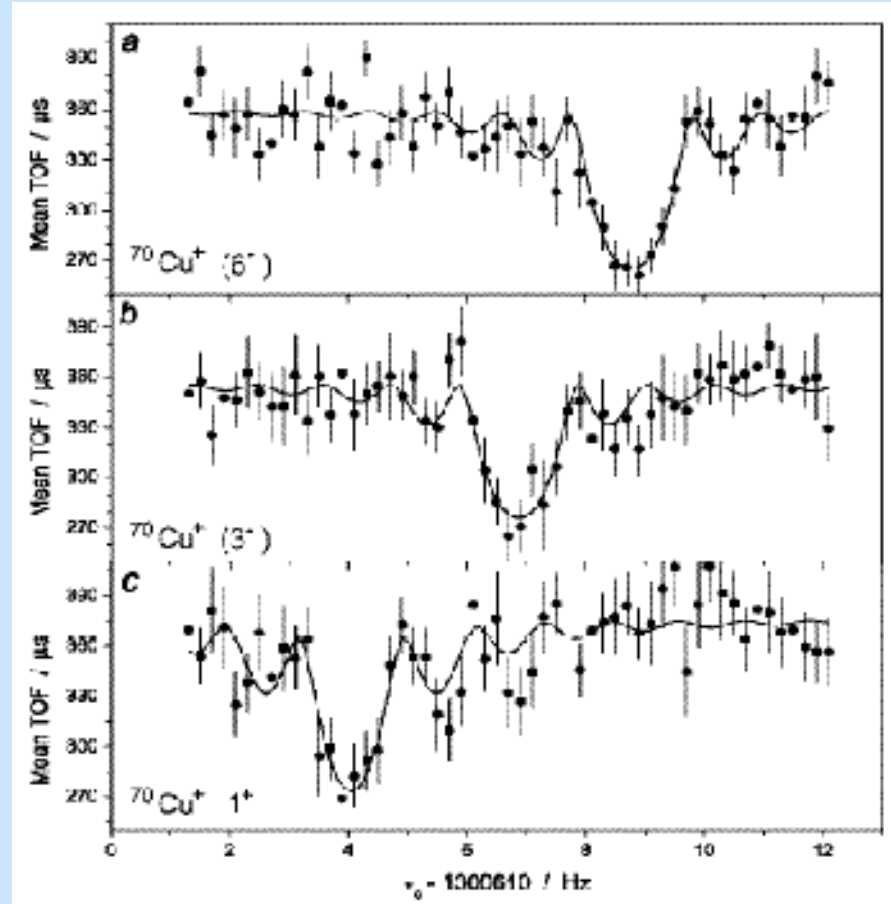

powerful technique to disentangle isomers!



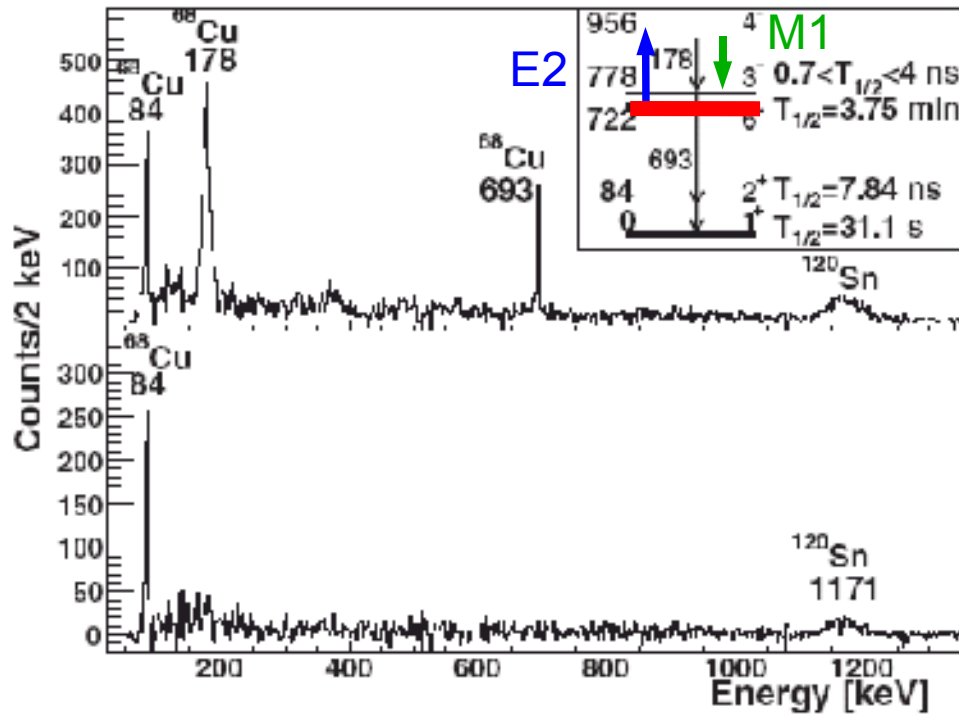

Offshoot:
isomeric beams for postacceleration

Coulex of odd-odd $^{68,70m}\text{Cu}$ at Rex-Isolde
2.83 MeV/n Cu + 2.3 mg/cm² ^{120}Sn

At Miniball

3 $\cdot 10^5$ pps $^{68}\text{Cu}(6-)$ 86(3)%
5 $\cdot 10^4$ pps $^{70}\text{Cu}(6-)$ 85(5)%
 $^{70}\text{Cu}(3-, 1+)$ each 7%

I Stefanescu, G Georgiev et al,
PRL98, 122701 (2007)

transfer on isomeric beams:
HIE Isolde, Spiral 2, Eurisol

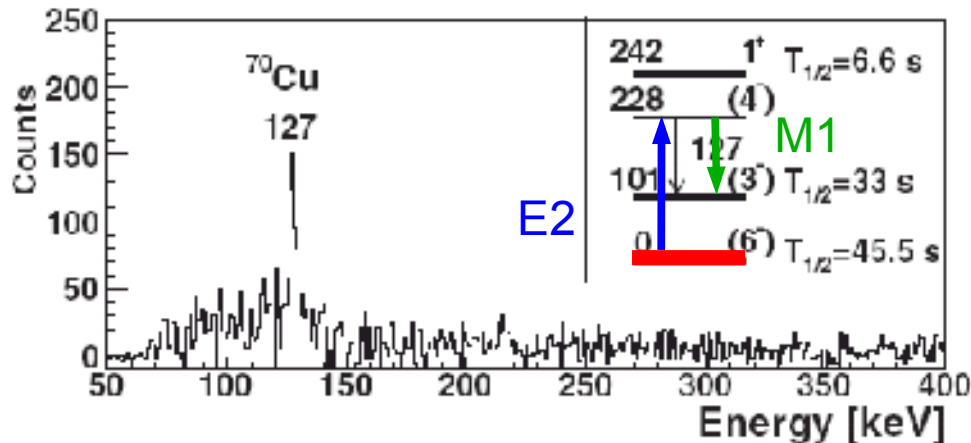

In-source spectroscopy

$$\delta\nu^{AA'} = (A'-A)/AA' (N+S) + F k \delta\langle r^2 \rangle^{AA'}$$

$$F(\text{Pb}, 283 \text{ nm}) = 20.26(18) \text{ GHz/fm}^2, k=0.93$$

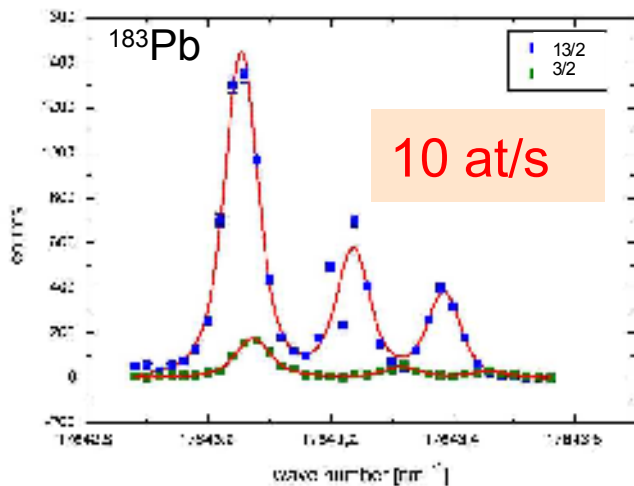
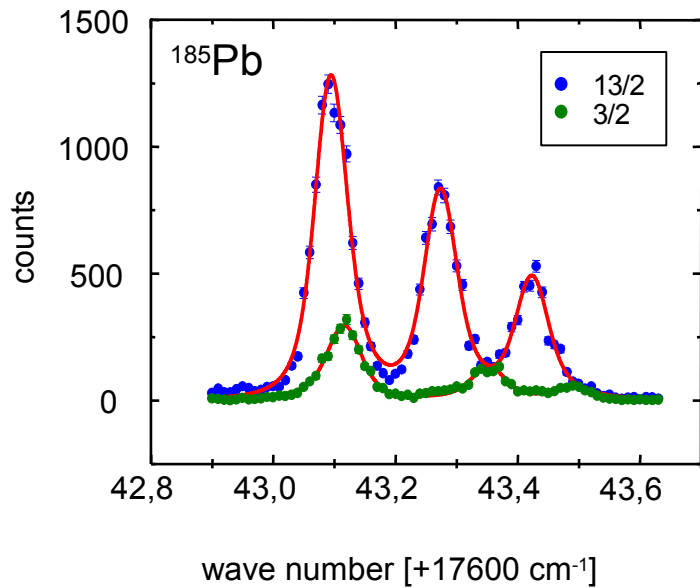

$$\Delta\nu_B = 1.2 \text{ GHz}, \Delta\nu_D = 2 \text{ GHz}$$

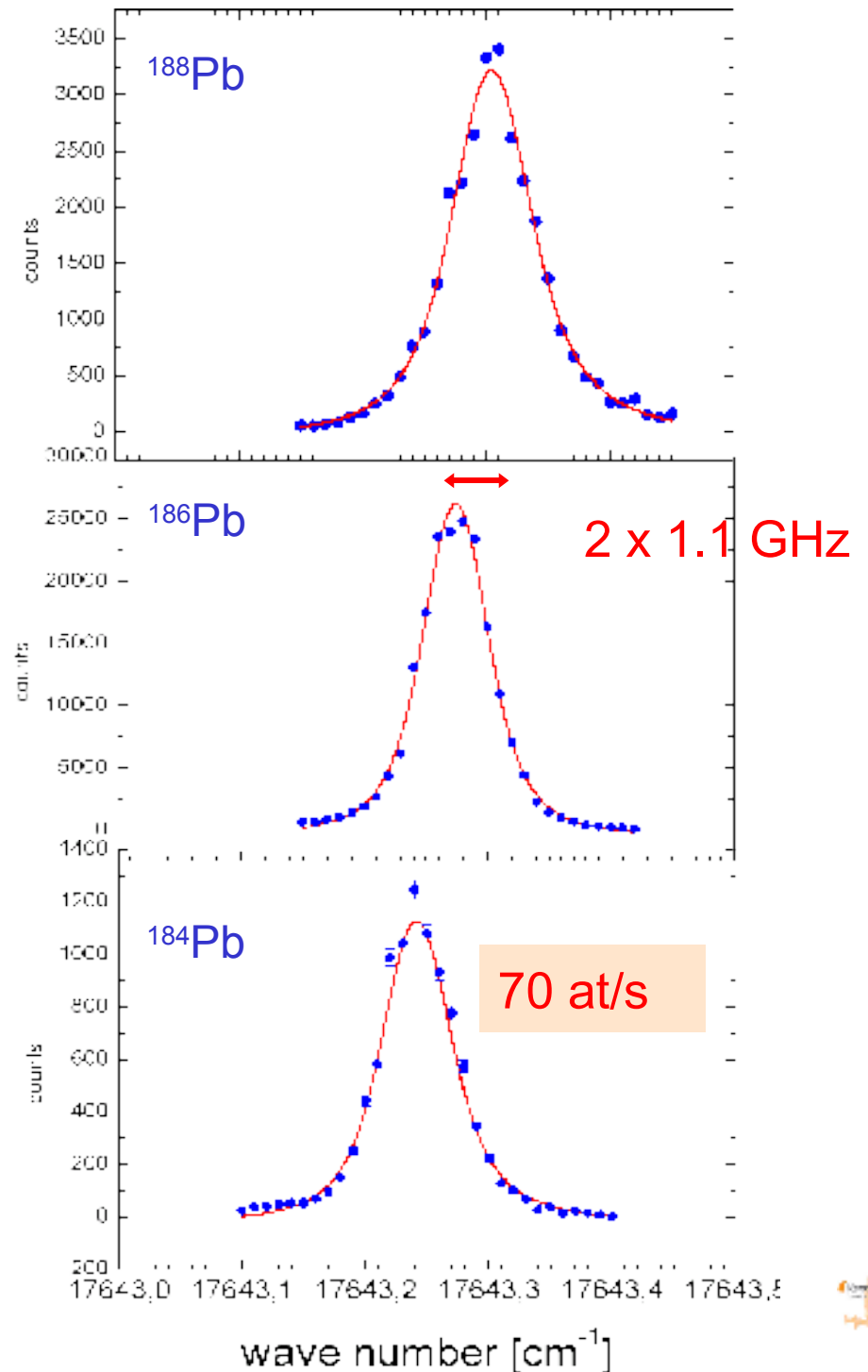

^{186}Pb shape coexistence
 A. Andreyev et al,
 Nature 405 (2000) 430

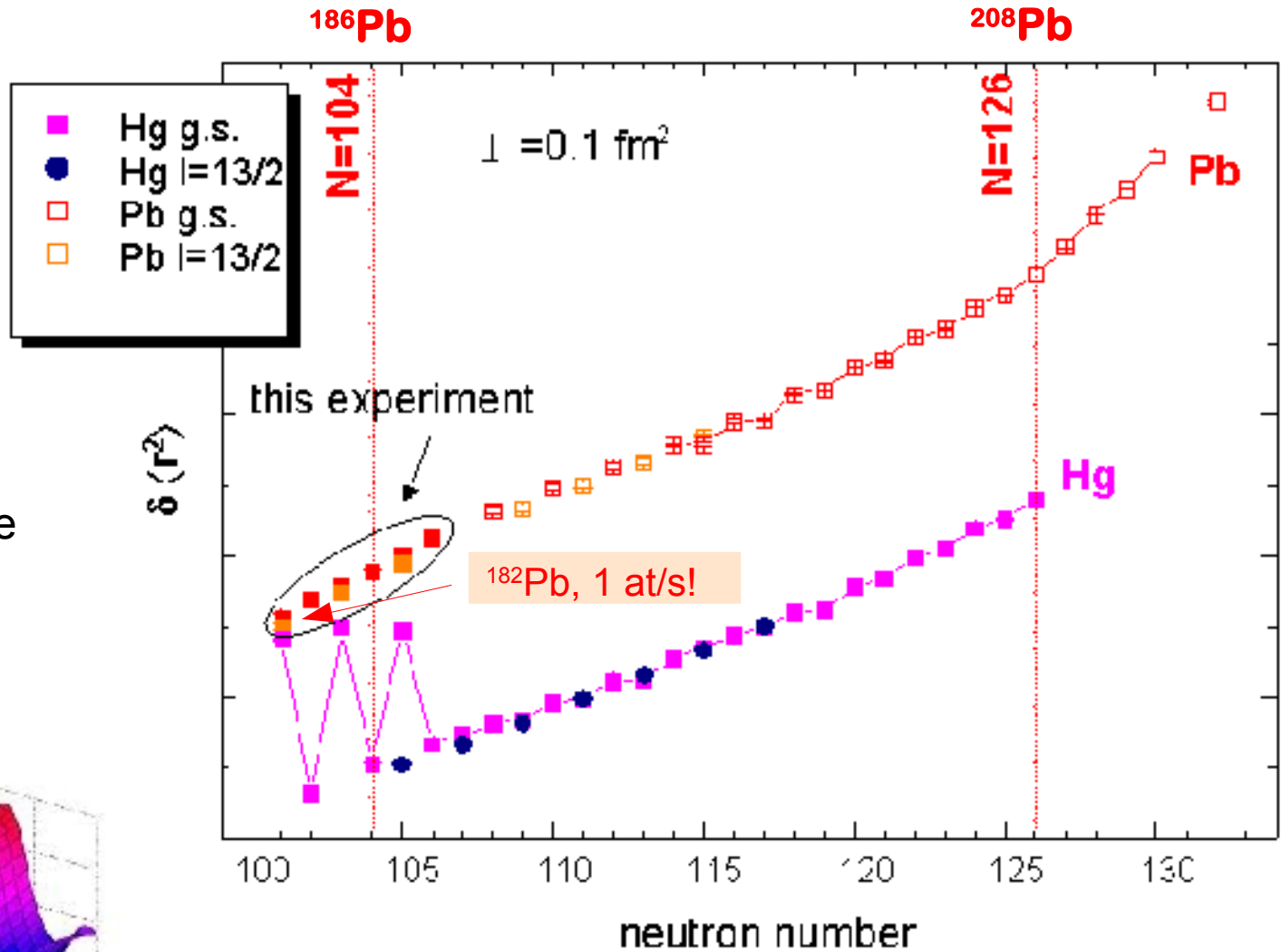
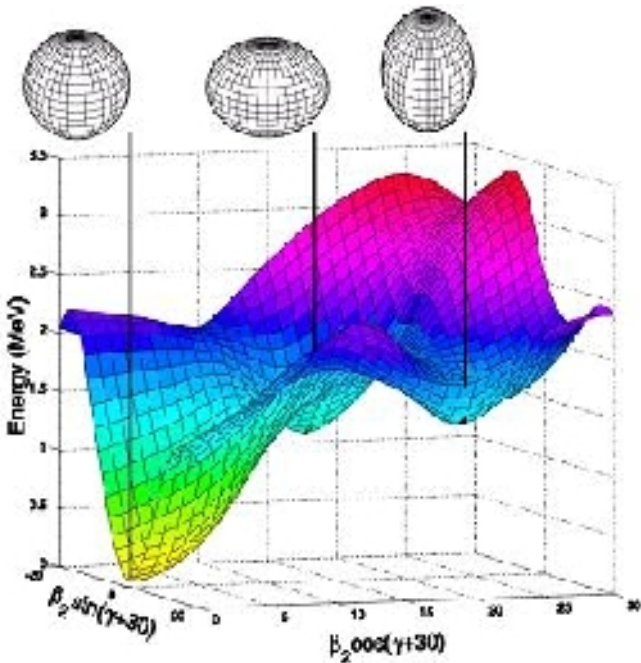

No mixing of deformed 0^+ into ground state
 H. De Witte et al, PRL 98, 112502 (2007)

2007: ^{193}Po
 T. Cocolios, Isolde Workshop December 2007



Electronic F factors of selected transitions in GHz/fm²

E. Otten, Treatise on Heavy Ion Science, vol. 8 p. 517 (1989)

$$F = \frac{\pi a_0^3}{Z} \Delta|\psi(0)|^2 f(z)$$

11	Na		-0.047	63	Eu	ss-sp	-6.55
19	K		-0.128	66	Dy	421	-7.26
37	Rb	780	-0.650	67	Ho	592	-8.41
38	Sr	407	-1.582(49)	68	Er	583	-8.08
47	Ag	547	-12.070(966)	69	Tm	597	-10.3
48	Cd	326	3.91(46)	70	Yb	555	-11.8
49	In		2.070(10)	78	Pt	266	-28
50	Sn	286	3.3(5)	79	Au	268	-43.07
54	Xe	823	-2.32	80	Hg	254	-55.36
55	Cs	852	-2.313	82	Pb	283	20.26(18)
56	Ba	455	-5.120	86	Rn	745	-22.1
60	Nd	588	-5.50	88	Ra	468	-49.6
62	Sm	600	-5.5				

large F factors for heavy elements only!



- laser band width
1.2 GHz at Isolde
600 MHz with seeding
- power broadening
 $\Delta v_{\text{Power}} = \Omega_{\text{Rabi}} / \pi = 10^7 I^{1/2} [\text{Hz (cm}^2/\text{W)}^{1/2}]$
1 MHz for 1 W/mm²
- pressure broadening
 $\Delta v_{\text{Pressure}} = 10^{-3} P [\text{cm}^{-1}/\text{mbar}]$
negligible unless gas cell
- **Doppler broadening**
 $\Delta v_{\text{Doppler}} = 7.16 \times 10^{-7} v_0 (T/M)^{1/2} [\text{cm}^{-1} (\text{amu}/\text{K})^{1/2}]$
2 GHz for Cu at Isolde (2300 K)

Y. Kudryavtsev et al., NIM B 114 350 (1996)

V. Fedoseyev et al., NIM B 204 353 (2003)

development of laser cavities at low temperature !



Doppler free two photon resonance

$$h\nu = h\nu/2 + h\nu/2$$

Doppler free

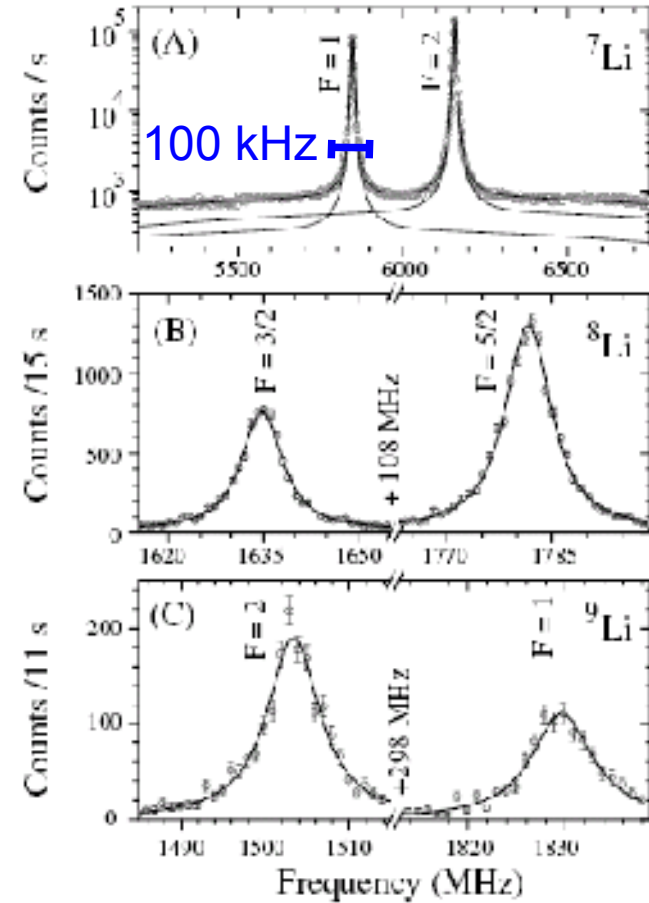
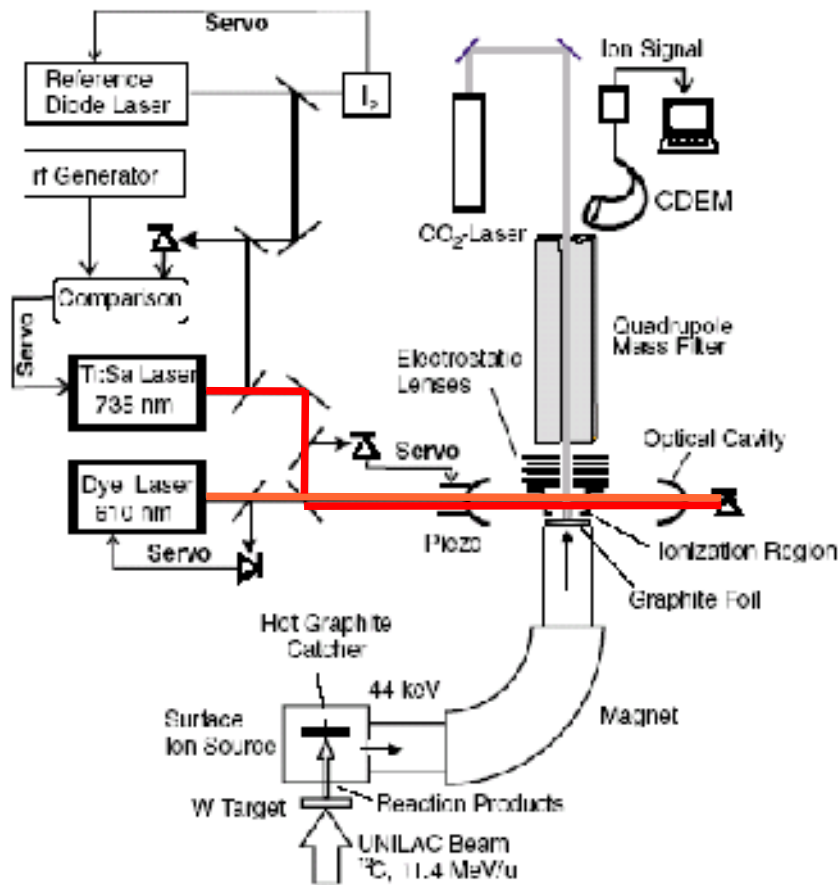

G Ewald et al, PRL94, 039901 (2005)

W Nörtershäuser et al, HI 162, 93 (2005) & EPJA 25 S1, 199 (2005)



Two photon laser spectroscopy in the ion source!

conventional laser ion source

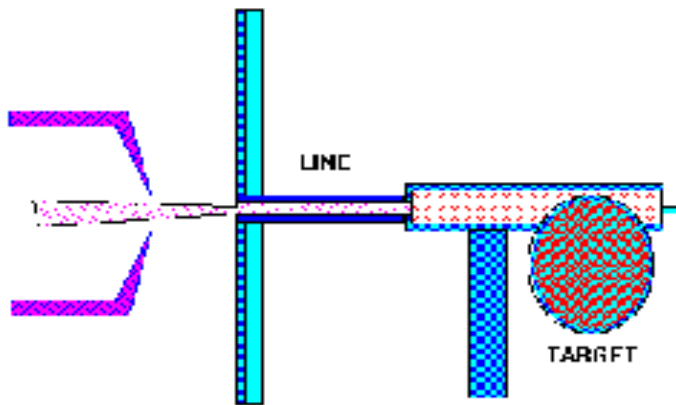

cavity with metal mirrors

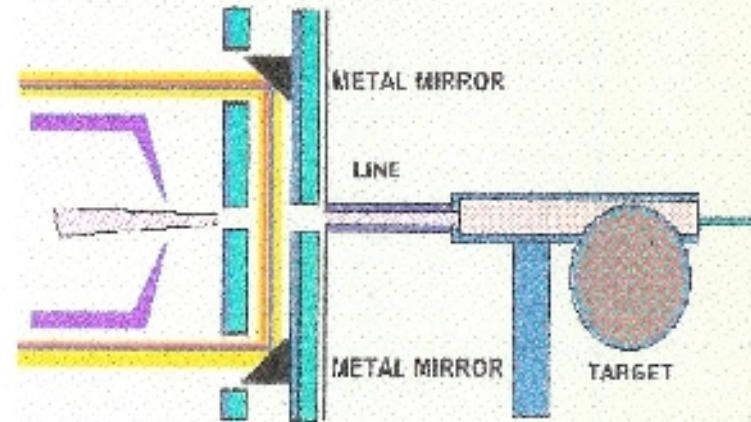

90° extraction

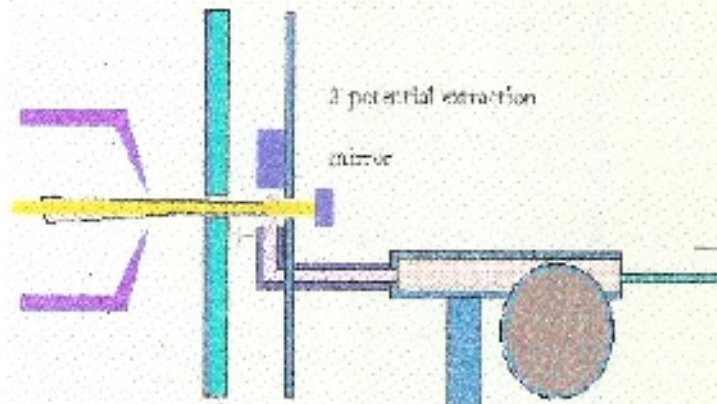

stable probe: $^{208}\text{Pb}(p,t)^{206}\text{Pb}$ at iThemba

$Q = -5.62 \text{ MeV}$

intensity $10\text{-}15 \text{ nA} = 10^{11} \text{ pps}$

GPV L=0 pairing mode spectrometer at 7° but no GPV seen

2008: modification for 0° mode

K600 SPECTROMETER

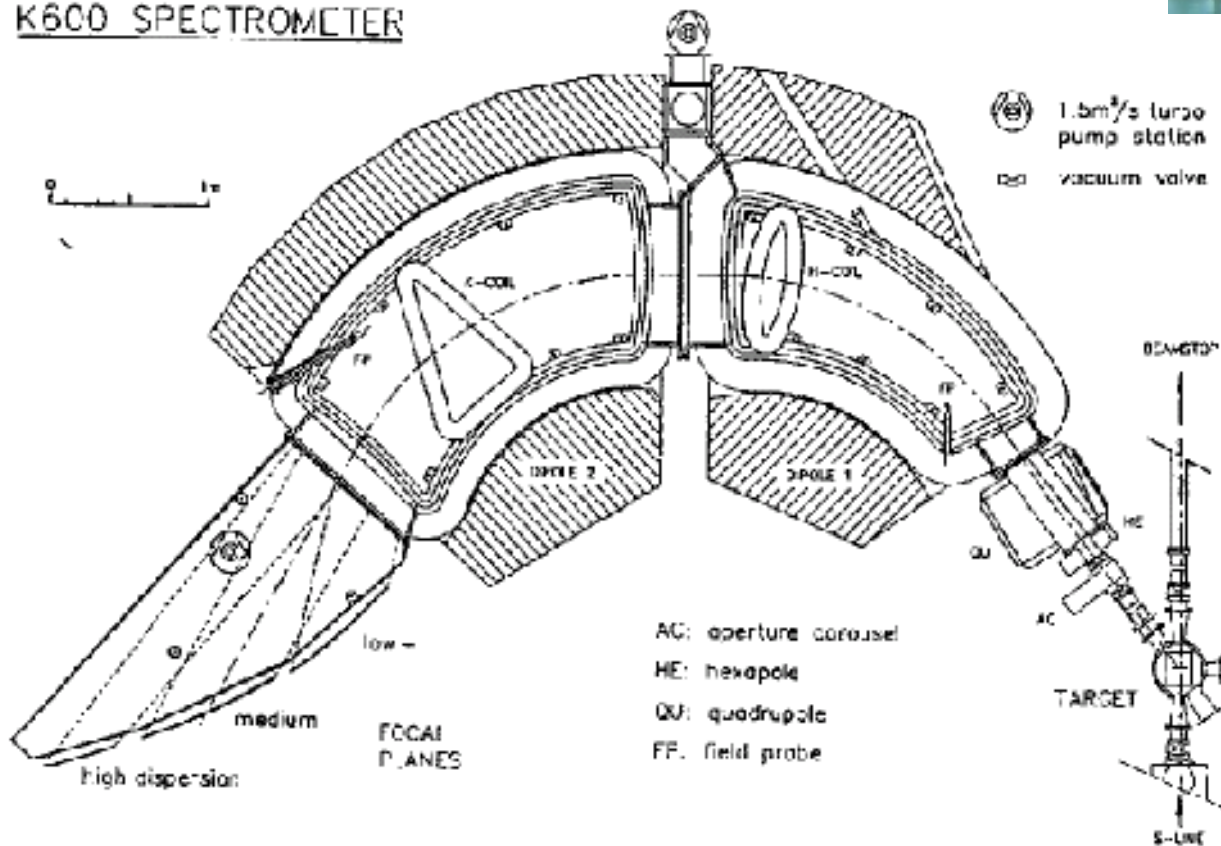

E. Khan, B. Mougnot
IPN Orsay

R. Neveling
iThemba



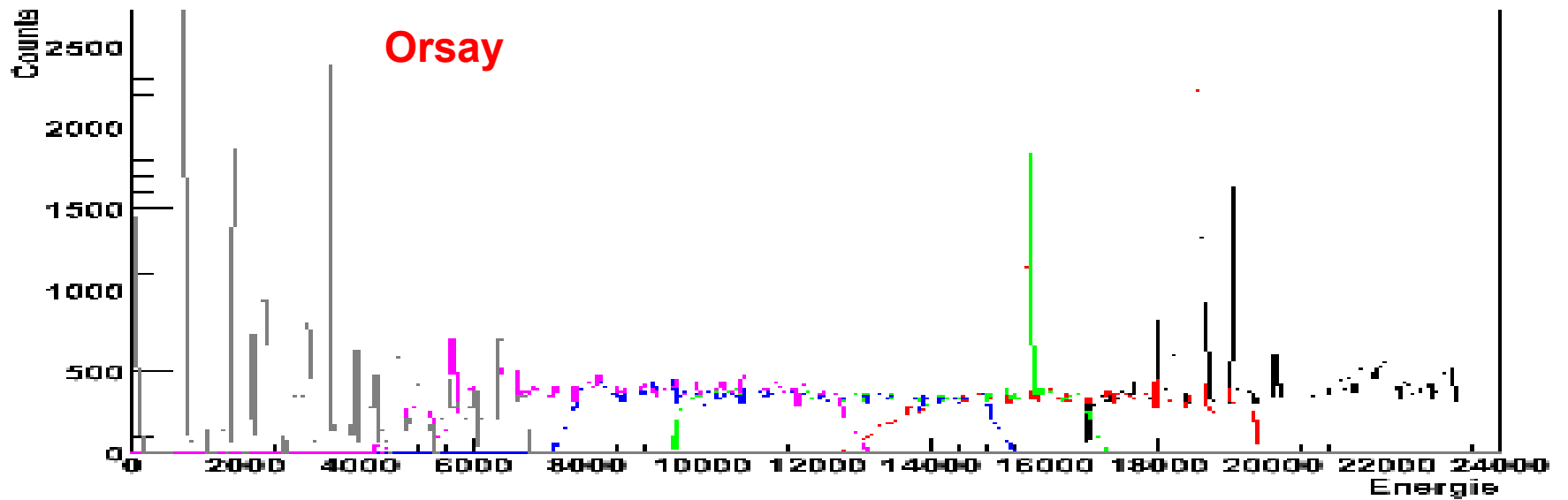
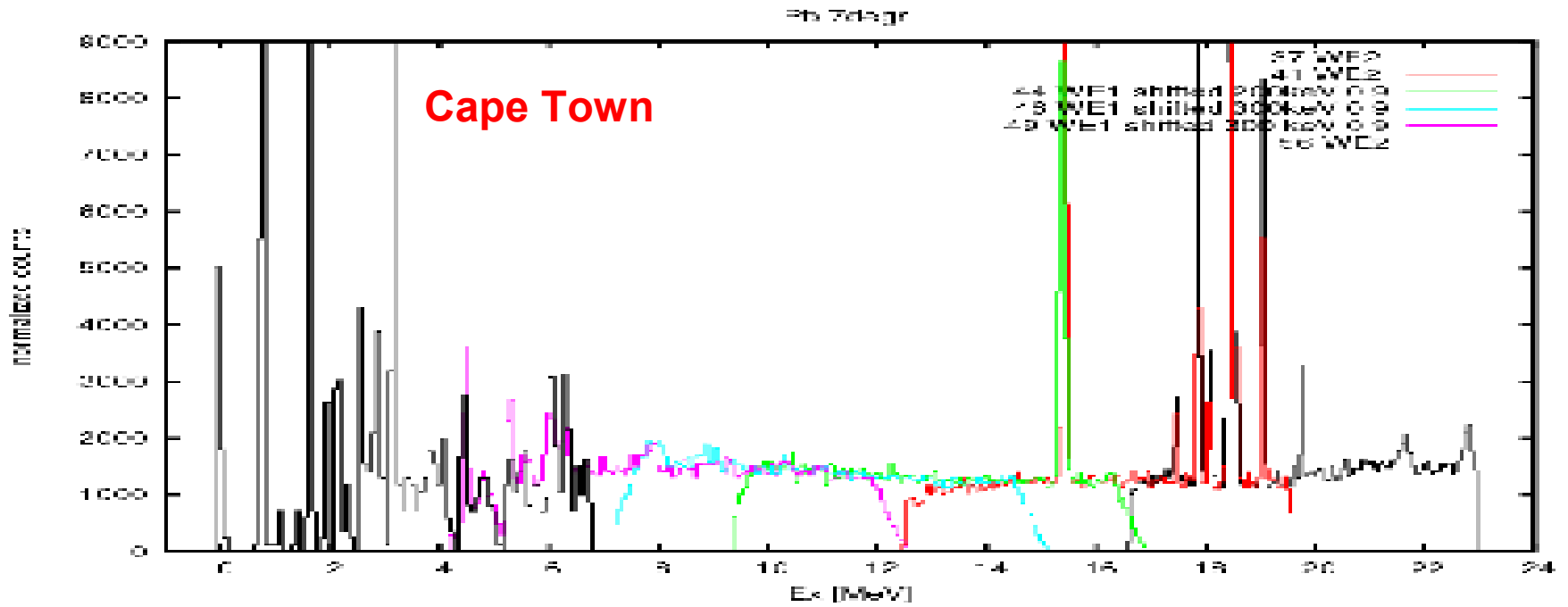

no GPV seen (yet) since not at 0°



${}^6\text{He}$ radioactive probe

better energy matching:
large Q value +8.15 MeV

RPA+DWBA: 1 mb cross section

cross section (${}^6\text{He}, {}^4\text{He}$) probe high if
dineutron configuration really exists!

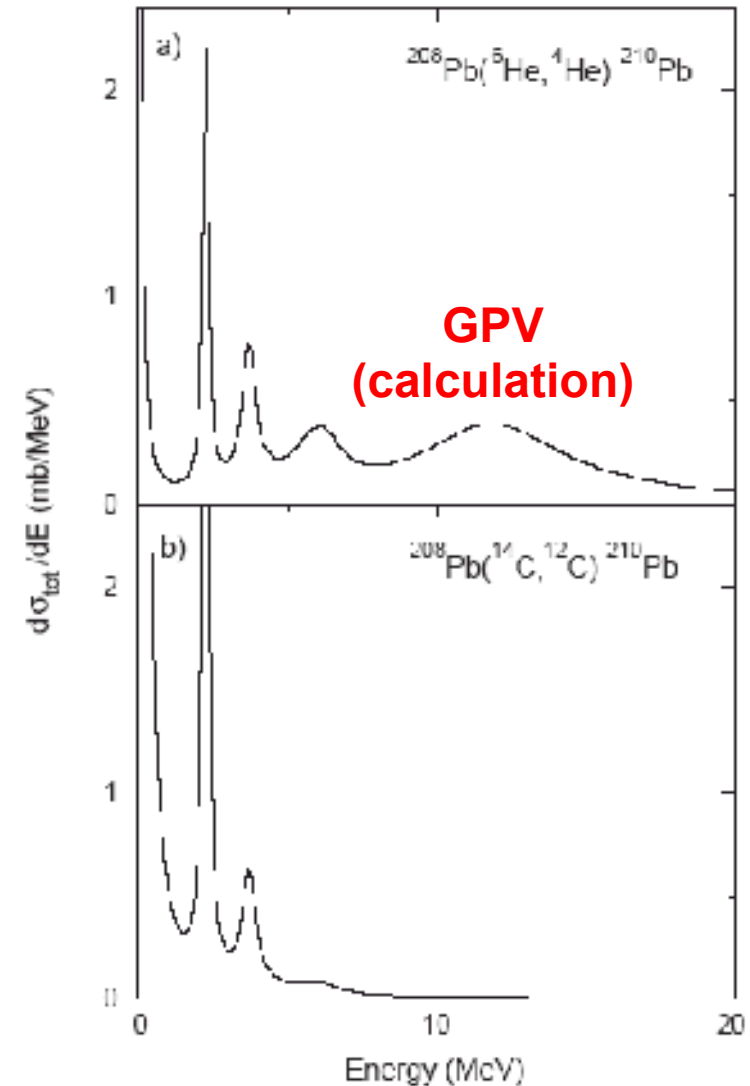

L Fortunato et al, EPJA 14, 37 (2002)



GPV: radioactive probe

radioactive probe: $^{208}\text{Pb}(^6\text{He}, ^4\text{He})^{210}\text{Pb}$ at Ganil
 $10^6\text{-}10^7$ pps ^6He at 20 MeV/u + 10 mg/cm^2 ^{208}Pb

No GPV seen...

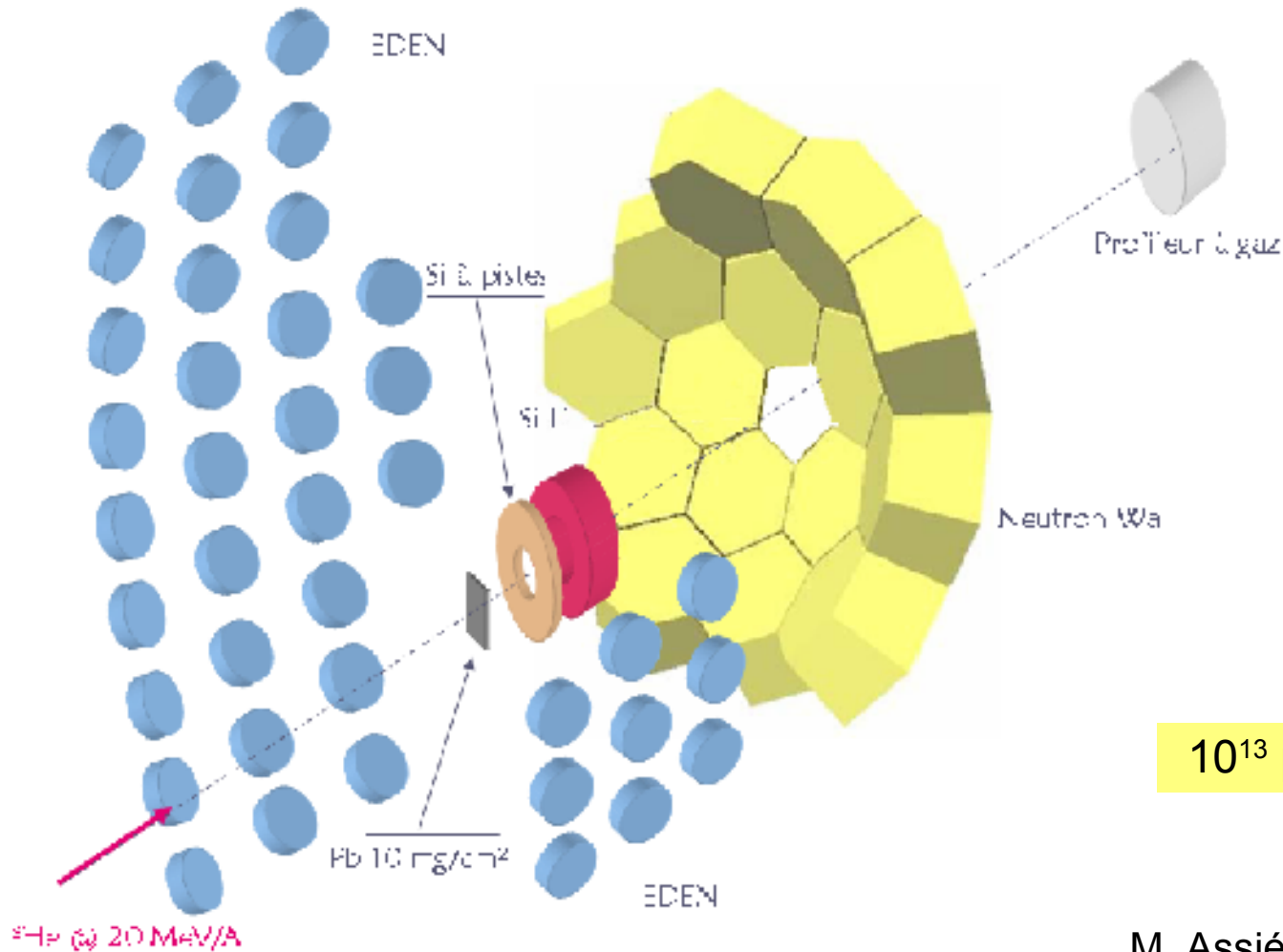

10^{13} pps ^6He at Eurisol!

M. Assié, JA Scarpaci, IPN Orsay



Laser ion source

production of RIB
management of radioactive inventory

Isomeric beams

Lasers at Eurisol for In Source spectroscopy
sensitivity of 10 atoms/s at resonance
Doppler free two photon spectroscopy
modify design of laser ion source

Giant pairing vibration

searched for since thirty years
better energy matching with radioactive probe
Eurisol intensity $\times 10^6$

